

EMC TEST REPORT

For

UNI-TREND TECHNOLOGY (CHINA) LIMITED

Power and Harmonics Clamp Meters

Model No.: UT240 Series (UT241\UT242\UT243)

Prepared for : UNI-TREND TECHNOLOGY (CHINA) LIMITED
Address : No. 6, Gongyebai 1st Road, Songshan Lake National
High-Tech Industrial Development Zone, Dongguan City,
Guangdong Province, China

Prepared By : DONGGUAN EMTEK CO., LTD.
Address : No.281, Guantai Road, Nancheng District, Dongguan,
Guangdong, China
Tel : +86-769-22807078
Fax: +86-769-22807079

Report Number : ED150814161E
Date of Test : November 04, 2011 to November 16, 2011
Date of Report : August 21, 2015

TABLE OF CONTENTS

Test Report Description	Page
1. DESCRIPTION OF STANDARDS AND RESULTS (EUT).....	5
2. GENERAL INFORMATION.....	6
2.1. Description of Device (EUT).....	6
2.2. Description of Test Facility.....	7
2.3. Measurement Uncertainty.....	7
3. MEASURING DEVICES AND TEST EQUIPMENT.....	8
3.1. For Radiated Emission Measurement.....	8
3.2. For Electrostatic Discharge Test.....	8
3.3. For RF Strength Susceptibility Test.....	8
4. RADIATED EMISSION MEASUREMENT.....	9
4.1. Block Diagram of Test.....	9
4.2. Measuring Standard.....	9
4.3. Radiated Emission Limits.....	10
4.4. EUT Configuration on Test.....	10
4.5. Operating Condition of EUT.....	10
4.6. Test Procedure.....	10
4.7. Test Results.....	10
5. ELECTROSTATIC DISCHARGE TEST.....	13
5.1. Block Diagram of Test Setup.....	13
5.2. Test Standard.....	13
5.3. Severity Levels and Performance Criterion.....	14
5.4. EUT Configuration.....	14
5.5. Operating Condition of EUT.....	14
5.6. Test Procedure.....	15
5.7. Test Results.....	15
6. RF FIELD STRENGTH SUSCEPTIBILITY TEST.....	17
6.1. Block Diagram of Test Setup.....	17
6.2. Test Standard.....	18
6.3. Severity Levels and Performance Criterion.....	18
6.4. EUT Configuration.....	18
6.5. Operating Condition of EUT.....	18
6.6. Test Procedure.....	19
6.7. Test Results.....	19
7. PHOTOGRAPH.....	21
7.1. Photo of Radiation Emission Measurement.....	21

APPENDIX (Photos of EUT) (2 pages)

TEST REPORT DESCRIPTION

Applicant : UNI-TREND TECHNOLOGY (CHINA) LIMITED
Manufacturer : UNI-TREND TECHNOLOGY (CHINA) LIMITED
EUT : Power and Harmonics Clamp Meters
Model No. : UT240 Series (UT241\UT242\UT243)
Input Rating : DC 6V

Measurement Procedure Used:

EN 61326-1: 2013
EN 61326-2-2: 2013
(IEC 61000-4-2: 2008, IEC 61000-4-3: 2006+ A1: 2007+ A2: 2010)

The device described above is tested by DONGGUAN EMTEK CO., LTD. and SHENZHEN EMTEK CO., LTD. to determine the maximum emission levels emanating from the device and the severe levels of the device can endure and its performance criterion. The measurement results are contained in this test report and DONGGUAN EMTEK CO., LTD. is assumed full responsibility for the accuracy and completeness of these measurements. Also, this report shows that the EUT to be technically compliant with the EN 55022 and EN 55024 requirements.

This report applies to above tested sample only and shall not be reproduced in part without written approval of DONGGUAN EMTEK CO., LTD.

Date of Test : November 04, 2011 to November 16, 2011

Prepared by :

Vivian Zhang
Vivian Zhang/Editor

Reviewer :

Alan He
Alan He/Supervisor

Approved & Authorized Signer :

Sam Lv
Sam Lv/Manager



Modified Information

Version	Summary	Revision Date	Report No.
Ver.1.0	Original Report	/	A001P111103009E, (From Shenzhen AOV Testing Technology Co., Ltd.)
Ver.1.0	Updated the standard version and changed applicant and manufacture information	2015-08-15	ED150814161E

1. DESCRIPTION OF STANDARDS AND RESULTS (EUT)

EMISSION			
Description of Test Item	Standard	Limits	Results
Conducted Disturbance at Mains Terminals	EN 61326-1: 2013	Clause 5	N/A
Radiated Disturbance	EN 61326-1: 2013	Clause 6	Pass
Harmonic Current Emissions	EN 61000-3-2: 2014	Class A	N/A
Voltage Fluctuation and Flicker	EN 61000-3-3: 2013	Section 5	N/A
IMMUNITY			
Description of Test Item	Basic Standard	Performance Criteria	Results
Electrostatic Discharge (ESD)	IEC 61000-4-2: 2008	B	Pass
Radio-Frequency, Continuous Radiated Disturbance	IEC 61000-4-3: 2006 +A1: 2007+A2: 2010	A	Pass
EFT/B Immunity	IEC 61000-4-4: 2012	B	N/A
Surge Immunity	IEC 61000-4-5: 2014	B	N/A
Conducted RF Immunity	IEC 61000-4-6: 2013	A	N/A
Power Frequency Magnetic Field	IEC 61000-4-8: 2009	A	N/A
Voltage Dips, >95% Reduction	IEC 61000-4-11: 2004	B	N/A
Voltage Dips, 30% Reduction		C	N/A
Voltage Interruptions		C	N/A
Note: N/A is an abbreviation for Not Applicable.			

2. GENERAL INFORMATION

2.1. Description of Device (EUT)

EUT	: Power and Harmonics Clamp Meters
Model Number	: UT240 Series (UT241\UT242\UT243) (Note: They are quite same in circuit design and PCB layout, so all tests of this report are perform on model UT243.)
Trade Mark	: 
Power Supply	: DC 6V
Applicant	: UNI-TREND TECHNOLOGY (CHINA) LIMITED
Address	: No. 6, Gongyebei 1st Road, Songshan Lake National High-Tech Industrial Development Zone, Dongguan City, Guanadona Province. China
Manufacturer	: UNI-TREND TECHNOLOGY (CHINA) LIMITED
Address	: No. 6, Gongyebei 1st Road, Songshan Lake National High-Tech Industrial Development Zone, Dongguan City, Guangdong Province, China
Date of sample receiver	: November 04, 2011
Date of Test	: November 04, 2011 to November 16, 2011

2.2. Description of Test Facility

Site Description

EMC Lab : Accredited by CNAS, 2015.06.11
The certificate is valid until 2018.07.03
The Laboratory has been assessed and proved to be in compliance with CNAS/CL01:2006
The Certificate Registration Number is L3150

Accredited by TUV Rheinland, 2014.05.22
The certificate is valid until 2015.11.21
The Laboratory has been assessed according to the requirements ISO/IEC 17025: 2005

Accredited by FCC, June 18, 2014
The Certificate Number is 247565

Accredited by Industry Canada, February 19, 2014
The Certificate Number is 9444A.

Name of Firm : DONGGUAN EMTEK CO., LTD.
Site Location : No.281, Guantai Road, Nancheng District, Dongguan, Guangdong, China

2.3. Measurement Uncertainty

Conducted Emission Uncertainty : 2.42dB

Radiated Emission Uncertainty : 3.34dB (30M~1GHz Polarize: H)
(3m Chamber) : 3.32dB (30M~1GHz Polarize: V)

Uncertainty for R/S Test : 2.10dB(80MHz-200MHz)
1.76dB(200MHz-1000MHz)

Uncertainty for test site temperature : 0.6°C
and humidity : 4%

3. MEASURING DEVICES AND TEST EQUIPMENT

3.1. For Radiated Emission Measurement

Item	Equipment	Manufacturer	Model No.	Serial No.	Last Cal.	Cal. Interval
1.	Test Receiver	Rohde & Schwarz	ESCI	1166.5950.03	May 16, 2015	1 Year
2.	Bilog Antenna	Schwarzbeck	VULB9163	000141	May 16, 2015	1 Year
3.	Power Amplifier	CDS	RSU-M352	818	May 16, 2015	1 Year
4.	Power Amplifier	HP	8447F	OPT H64	May 16, 2015	1 Year
5.	Color Monitor	SUNSP0	SP-140A	N/A	May 16, 2015	1 Year
6.	Single Line Filter	JIANLI	XL-3	N/A	May 16, 2015	1 Year
7.	Single Phase Power Line Filter	JIANLI	DL-2X100B	N/A	May 16, 2015	1 Year
8.	3 Phase Power Line Filter	JIANLI	DL-4X100B	N/A	May 16, 2015	1 Year
9.	DC Power Filter	JIANLI	DL-2X50B	N/A	May 16, 2015	1 Year
10.	Cable	Schwarzbeck	PLF-100	519489	May 16, 2015	1 Year
11.	Cable	Rosenberger	CIL02	A0783566	May 16, 2015	1 Year
12.	Cable	Rosenberger	RG 233/U	525178	May 16, 2015	1 Year

3.2. For Electrostatic Discharge Test

Item	Equipment	Manufacturer	Model No.	Serial No.	Last Cal.	Cal. Interval
1	ESD Tester	TESEQ AG	NSG437	EE166	May 16, 2015	1 Year

3.3. For RF Strength Susceptibility Test

Item	Equipment	Manufacturer	Model No.	Serial No.	Last Cal.	Cal. Interval
1.	RF Power Meter. Dual Channel	BOONTON	4232A	10539	May 17, 2015	1 Year
2.	50ohm Diode Power Sensor	BOONTON	51011EMC	34236/34238	May 17, 2015	1 Year
3.	Broad-Band Horn Antenna	SCHWARZBECK	BBHA9120 L3F	332	May 17, 2015	1 Year
4.	Power Amplifier	PRANA	AP32MT215	N/A	May 17, 2015	1 Year
5.	Power Amplifier	MILMEGA	AS0102-55	N/A	May 17, 2015	1 Year
6.	Signal Generator	AEROFLEX	2023B	N/A	May 17, 2015	1 Year
7.	Field Strength Meter	HOLADAY	HI-6005	N/A	May 17, 2015	1 Year
8.	RS232 Fiber Optic Modem	HOLADAY	HI-4413P	N/A	May 17, 2015	1 Year
9.	Log.-Per. Antenna	SCHWARZBECK	VULP 9118E	N/A	May 17, 2015	1 Year

4. RADIATED EMISSION MEASUREMENT

4.1. Block Diagram of Test

4.1.1. Block diagram of connection between the EUT and simulators



(EUT: Power and Harmonics Clamp Meters)

4.1.2. Block diagram of test setup (In chamber)

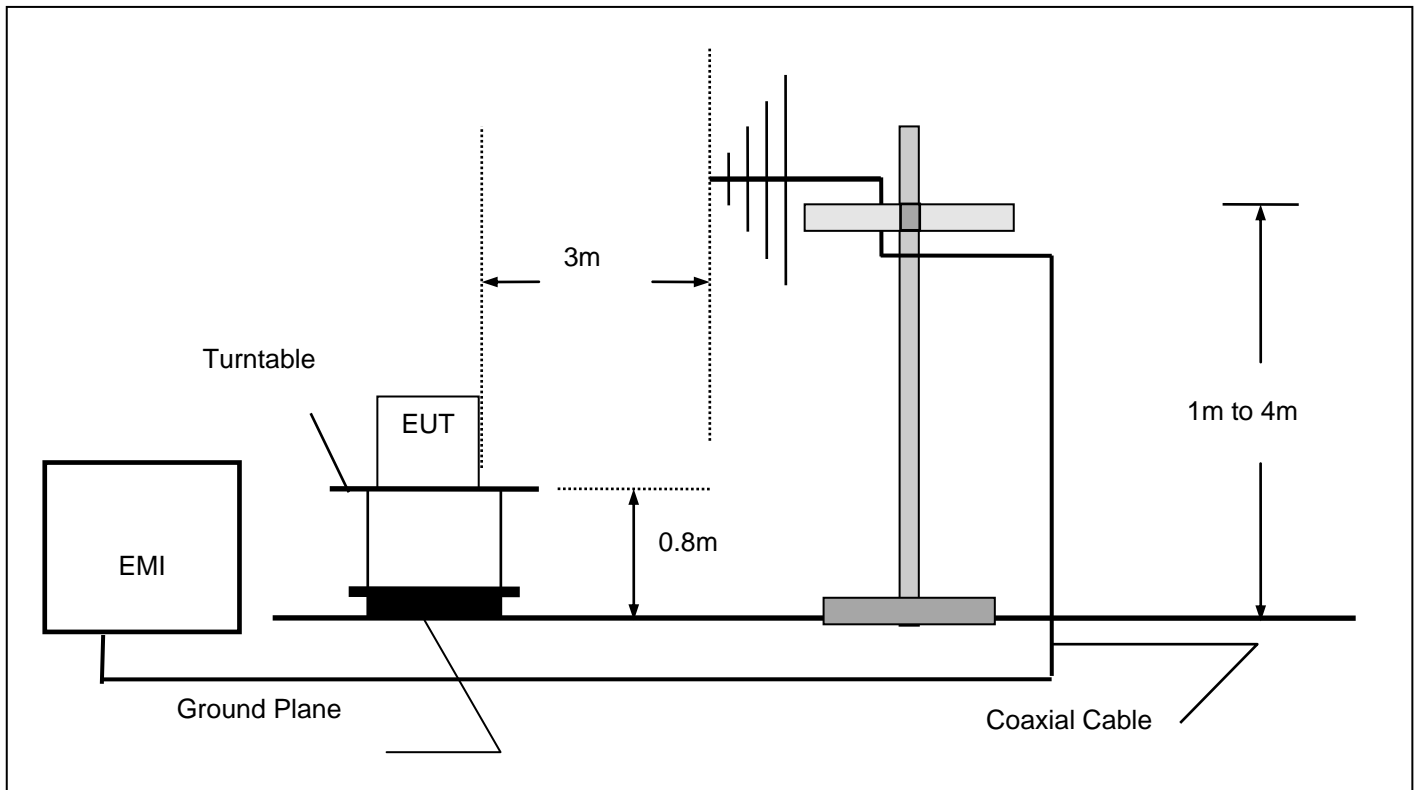

(EUT: Power and Harmonics Clamp Meters)

4.2. Measuring Standard

EN 61326-1: 2013

4.3. Radiated Emission Limits

All emanations from a device or system, including any network of conductors and apparatus connected thereto, shall not exceed the level of field strengths specified below:

Limits below 1GHz

FREQUENCY (MHz)	DISTANCE (Meters)	FIELD STRENGTHS LIMIT (dB μ V/m)
30 ~ 230	3	40
230 ~ 1000	3	47

Note: (1) The smaller limit shall apply at the combination point between two frequency bands.
(2) Distance refers to the distance in meters between the measuring instrument antenna and the closed point of any part of the EUT.

4.4. EUT Configuration on Test

The EN 61326-1 regulations test method must be used to find the maximum emission during radiated emission measurement.

EUT : Power and Harmonics Clamp Meters
Model Number : UT243

4.5. Operating Condition of EUT

4.5.1. Turn on the power.

4.5.2. Let the EUT work in test mode and measure it.

4.6. Test Procedure

The EUT is placed on a turn table which is 0.8 meter high above the ground. The turn table can rotate 360 degrees to determine the position of the maximum emission level. The EUT is set 3 meters away from the receiving antenna which is mounted on an antenna tower. The antenna can be moved up and down from 1 to 4 meters to find out the maximum emission level. Bilog antenna (calibrated by Dipole Antenna) is used as a receiving antenna. Both horizontal and vertical polarizations of the antenna are set on test.

The bandwidth of the Receiver (ESCI) is set at 120kHz.

The frequency range from 30MHz to 1000MHz is investigated.

The scanning waveforms are below a few pages.

4.7. Test Results

PASS.

The frequency range from 30MHz to 1000MHz is investigated.
Please see the attached pages.

Radiated Emission

Engineer : Andy	
EUT : Power and Harmonics Clamp Meters	Time : 2011/11/14
Limit : EN55022	Comment : 24°C/65%
MN:UT243	Note : Hor
Power : DC 6V	

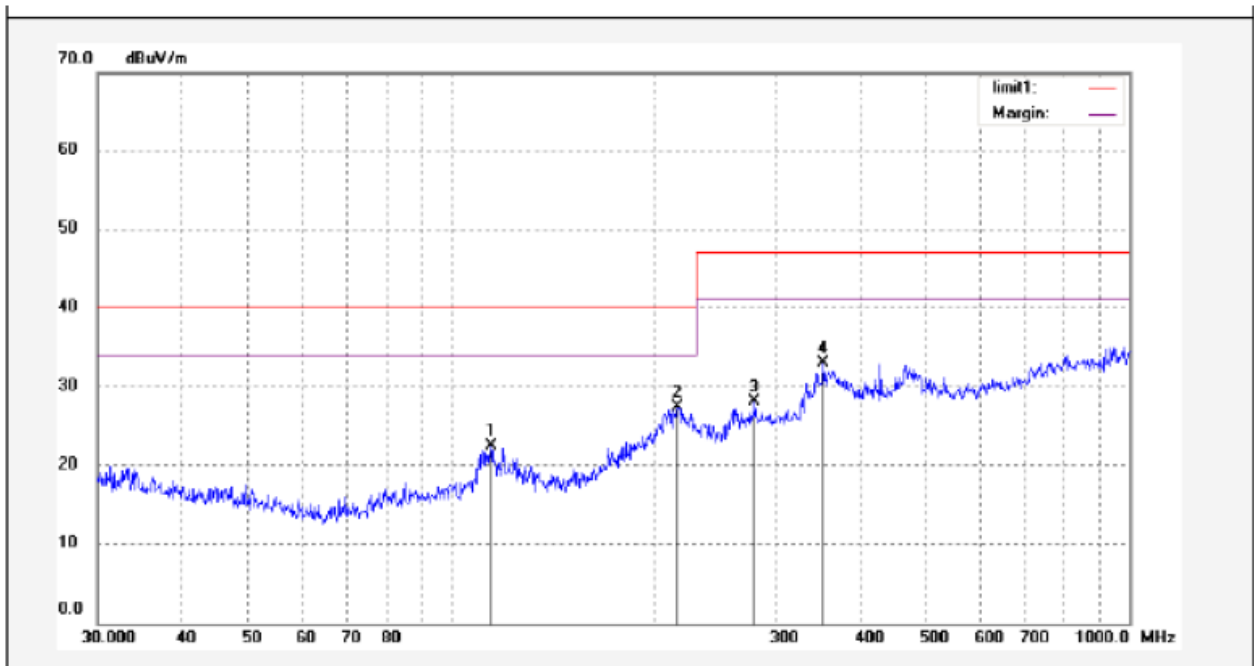

No.	Freq. (MHz)	Reading (dBuV/m)	Factor (dB)	Result (dBuV/m)	Limit (dBuV/m)	Margin (dB)	Detector	Height (cm)	Degree (deg.)	Remark
1	114.4197	8.19	14.24	22.43	40.00	-17.57	peak			
2	215.3616	10.90	16.55	27.45	40.00	-12.55	peak			
3	280.2936	9.76	18.29	28.05	47.00	-18.95	peak			
4	353.4471	12.06	21.01	33.07	47.00	-13.93	peak			

Radiated Emission

Engineer : Andy	
EUT : Power and Harmonics Clamp Meters	Time : 2011/11/14
Limit : EN55022	Comment : 24°C/65%
MN:UT243	Note : Ver
Power : DC 6V	

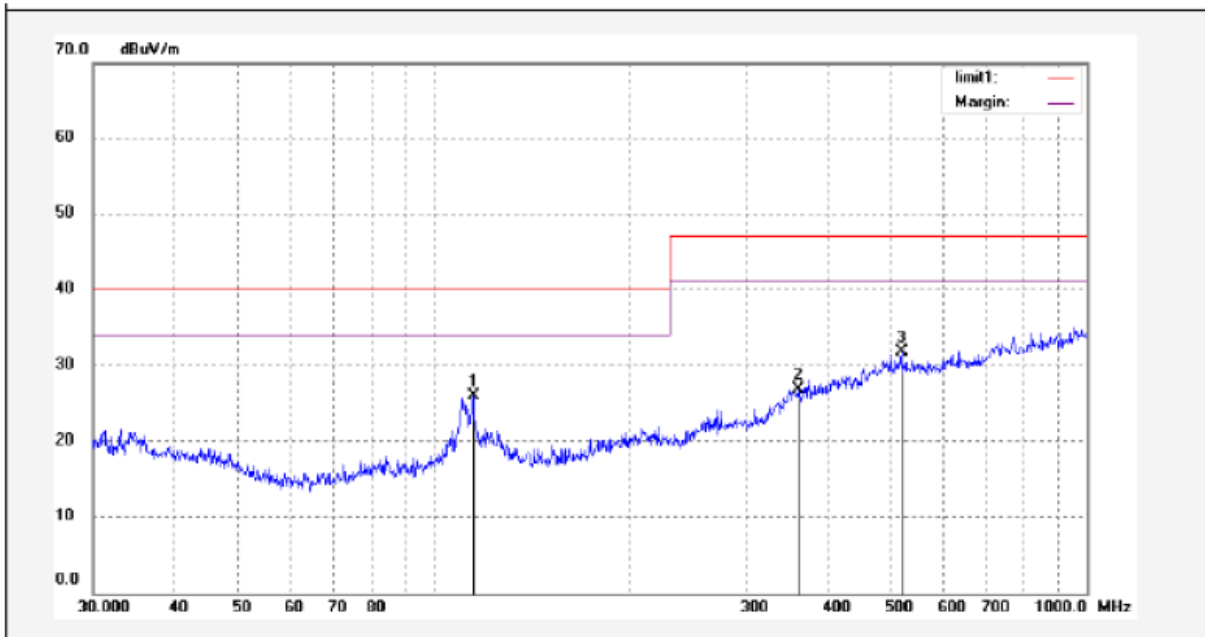

No.	Freq. (MHz)	Reading (dBuV/m)	Factor (dB)	Result (dBuV/m)	Limit (dBuV/m)	Margin (dB)	Detector	Height (cm)	Degree (deg.)	Remark
1	114.8224	11.72	14.27	25.99	40.00	-14.01	peak			
2	360.9775	5.60	21.29	26.89	47.00	-20.11	peak			
3	520.2078	7.62	24.08	31.70	47.00	-15.30	peak			

5. ELECTROSTATIC DISCHARGE TEST

5.1. Block Diagram of Test Setup

5.1.1. Block diagram of connection between the EUT and simulators



(EUT: Power and Harmonics Clamp Meters)

5.1.2. Block Diagram of ESD Test Setup

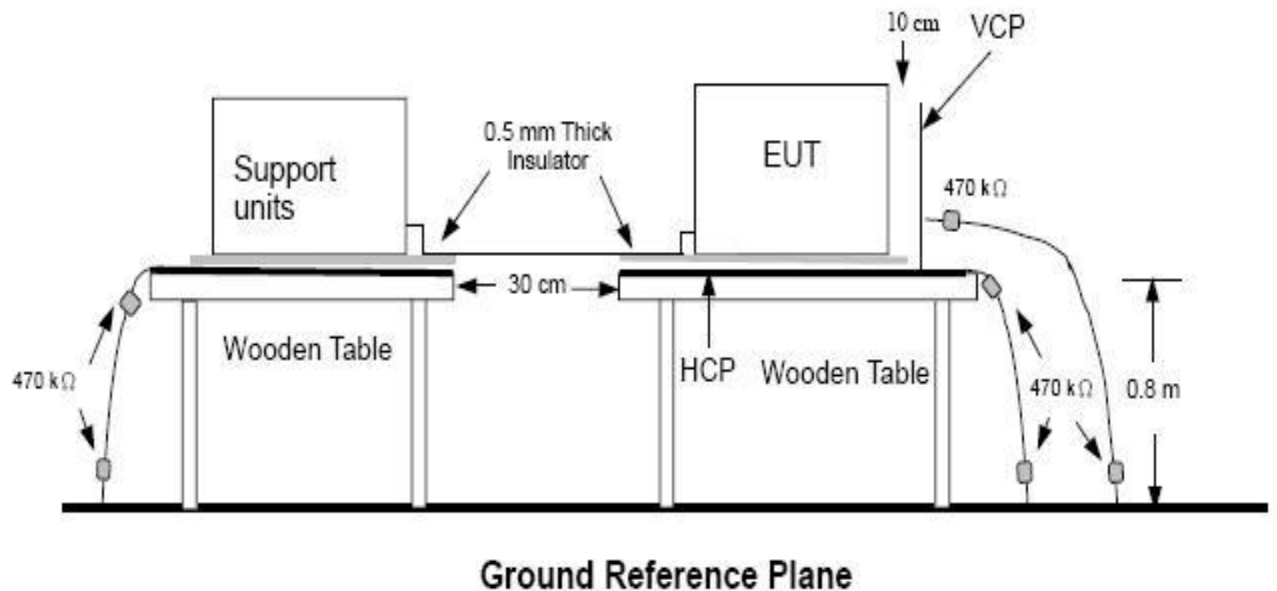

(EUT: Power and Harmonics Clamp Meters)

5.2. Test Standard

EN 61326-2-2: 2013

(IEC 61000-4-2: 2008 (Severity Level: 2 / Contact Discharge: $\pm 4\text{KV}$
Severity Level: 3 / Air Discharge: $\pm 8\text{KV}$))

5.3. Severity Levels and Performance Criterion

5.3.1. Severity level

Level	Test Voltage Contact Discharge (KV)	Test Voltage Air Discharge (KV)
1.	±2	±2
2.	±4	±4
3.	±6	±8
4.	±8	±15
X	Special	Special

5.3.2. Performance criterion: **B**

5.4. EUT Configuration

The configuration of EUT is listed in Section 4.4.

5.5. Operating Condition of EUT

5.5.1. Setup the EUT as shown in Section 5.1.

5.5.2. Turn on the power of all equipments.

5.5.3. Let the EUT work in test mode (ON) and measure it.

5.6. Test Procedure

5.6.1. Air Discharge:

This test is done on a non-conductive surface. The round discharge tip of the discharge electrode shall be approached as fast as possible to touch the EUT. After each discharge, the discharge electrode shall be removed from the EUT. The generator is then re-triggered for a new single discharge and repeated 10 times for each pre-selected test point. This procedure shall be repeated until all the air discharge completed.

5.6.2. Contact Discharge:

All the procedure shall be same as Section 5.6.1. except that the tip of the discharge electrode shall touch the EUT before the discharge switch is operated.

5.6.3. Indirect discharge for horizontal coupling plane:

At least 20 single discharges shall be applied to the horizontal coupling plane, at points on each side of the EUT. The discharge electrode positions vertically at a distance of 0.1m from the EUT and with the discharge electrode touching the coupling plane.

5.6.4. Indirect discharge for vertical coupling plane:

At least 20 single discharge shall be applied to the center of one vertical edge of the coupling plane. The coupling plane, of dimensions 0.5m X 0.5m, is placed parallel to, and positioned at a distance of 0.1m from the EUT. Discharges shall be applied to the coupling plane, with this plane in sufficient different positions that the four faces of the EUT are completely illuminated.

5.7. Test Results

PASS.

Please refer to the following page.

6. RF FIELD STRENGTH SUSCEPTIBILITY TEST

6.1. Block Diagram of Test Setup

6.1.1. Block diagram of connection between the EUT and simulators



(EUT: Power and Harmonics Clamp Meters)

6.1.2. Block diagram of R/S test set up

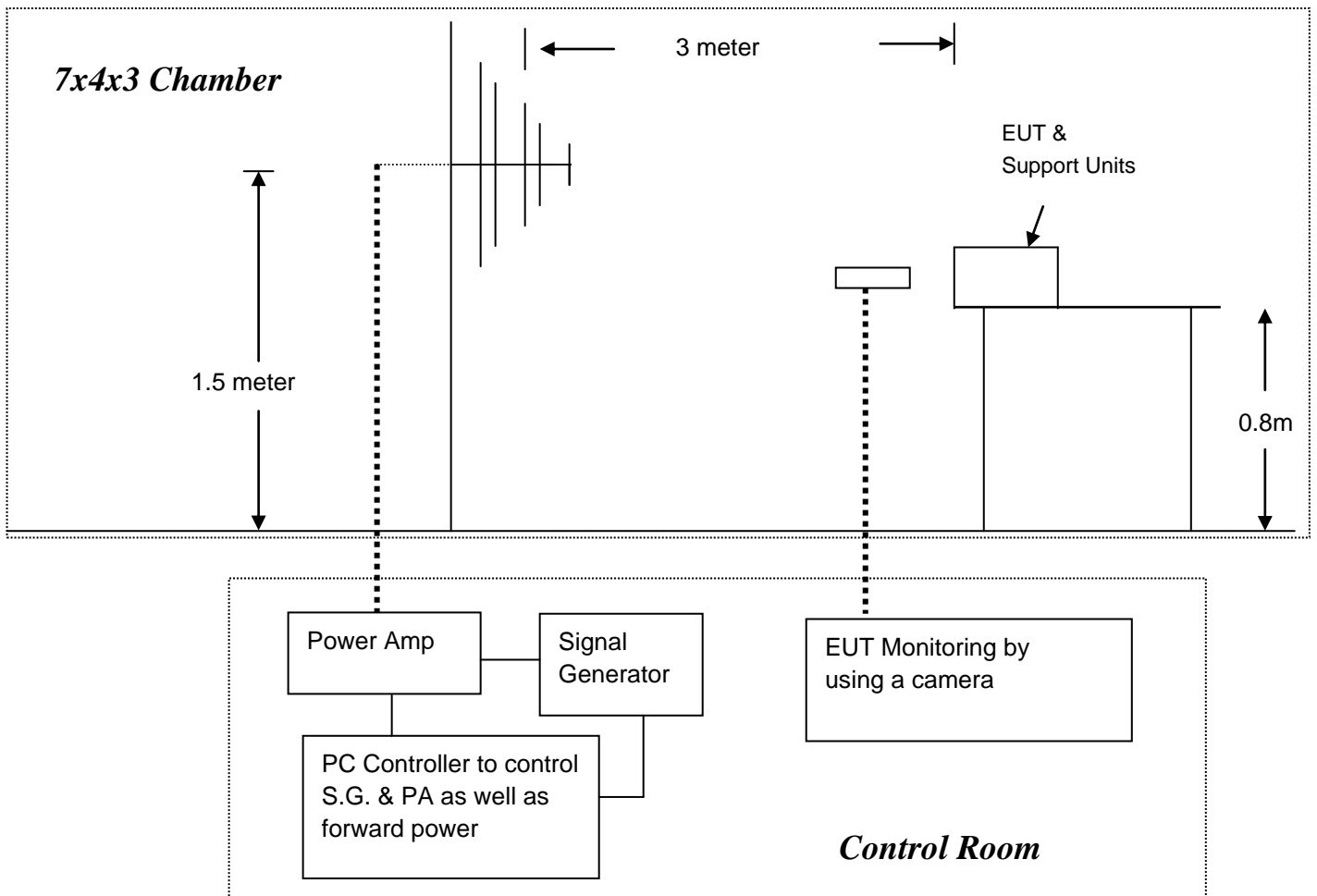

(EUT: Power and Harmonics Clamp Meters)

6.2. Test Standard

EN 61326-2-2: 2013
(IEC 61000-4-3: 2006+ A1: 2007+ A2: 2010 (Severity Level: 1, 1V / m , 2, 3V / m))

6.3. Severity Levels and Performance Criterion

6.3.1. Severity level

Level	Field Strength V/m
1.	1
2.	3
3.	10
X	Special

6.3.2. Performance criterion: **A**

6.4. EUT Configuration

The configurations of EUT are listed in Section 4.4.

6.5. Operating Condition of EUT

6.5.1. Setup the EUT as shown in Section 6.1.

6.5.2. Turn on the power of all equipments.

6.5.3. Let the EUT work in test mode (ON) and measure it.

6.6. Test Procedure

The EUT and its simulators are placed on a turn table which is 0.8 meter above ground. EUT is set 3 meter away from the transmitting antenna which is mounted on an antenna tower. Both horizontal and vertical polarizations of the antenna are set on test. Each of the four sides of EUT must be faced this transmitting antenna and measured individually. In order to judge the EUT performance, a CCD camera is used to monitor EUT screen. All the scanning conditions are as follows:

Condition of Test	Remarks
Fielded Strength	1 V/m, 3 V/m (Severity Level1, 2)
Radiated Signal	Modulated
Scanning Frequency	80 - 1000 MHz, 1400MHz-2000MHz, 2000MHz-2700MHz
Dwell time of radiated	0.0015 decade/s
Waiting Time	1 Sec.

6.7. Test Results

PASS.

These test result outsourced to SHENZHEN EMTEK CO., LTD.

Please refer to the following page.

RF Field Strength Susceptibility Test Results

SHENZHEN EMTEK CO., LTD

Applicant: <u>UNI-TREND TECHNOLOGY (CHINA) LIMITED</u>	Test Date : <u>November 15, 2011</u>
EUT : <u>Power and Harmonics Clamp Meters</u>	Temperature : <u>22°C</u>
M/N : <u>UT243</u>	Humidity : <u>52%</u>
Field Strength: <u>3 V/m</u>	Criterion: <u>A</u>
Power Supply: <u>DC 6V</u>	Frequency Range: <u>80</u> MHz to <u>1000</u> MHz
Test Engineer: <u>Jees</u>	
Modulation: <input checked="" type="checkbox"/> AM <input type="checkbox"/> Pulse <input type="checkbox"/> none 1 KHz 80%	
Test Mode : <u>ON</u>	

	Frequency Rang : 80-1000MHz	
Steps	1 %	
	Horizontal	Vertical
Front	PASS	PASS
Right	PASS	PASS
Rear	PASS	PASS
Left	PASS	PASS

Test Equipment :

1. Signal Generator : 2023B (AEROFLEX)
2. Power Amplifier : AS0102-55 (MILMEGA)& AP32MT215 (PRANA)
3. Log.-Per. Antenna: VULP 9118E(SCHWARZBECK)
4. Broad-Band Horn Antenna: BBHA9120L3F (SCHWARZBECK)
5. RF Power Meter. Dual Channel : 4232A (BOONTON)
6. Field Strength Meter: HI-6005(HOLADAY)

Note:

7. PHOTOGRAPH

7.1. Photo of Radiation Emission Measurement

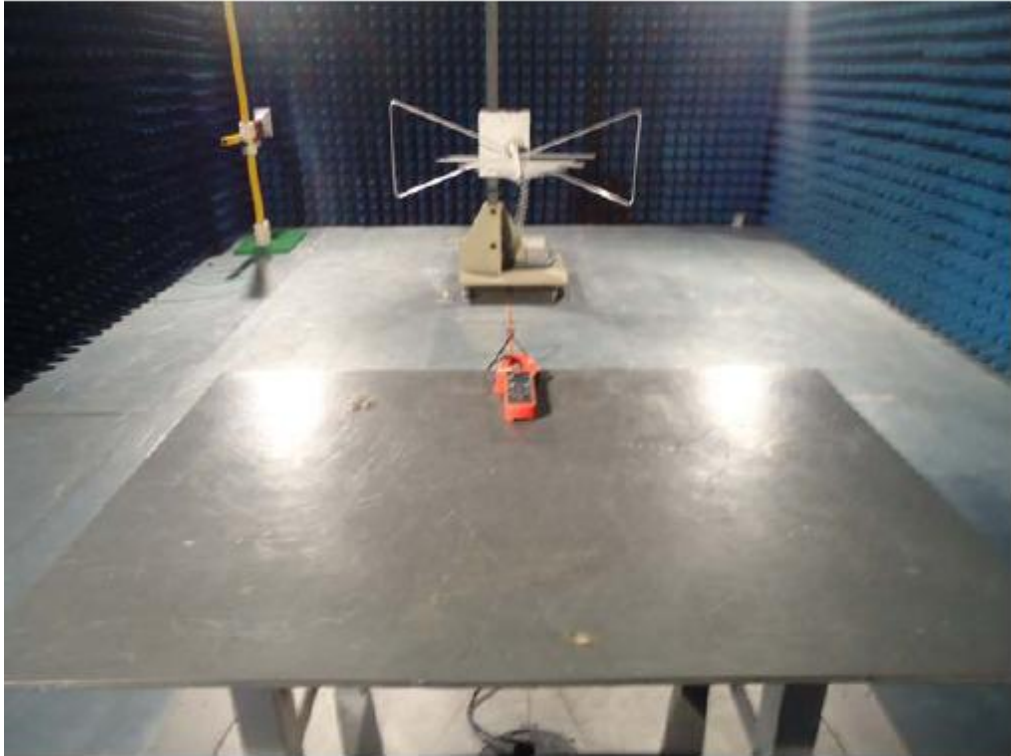

APPENDIX (Photos of EUT)



